

SPECIAL PRODUCTS

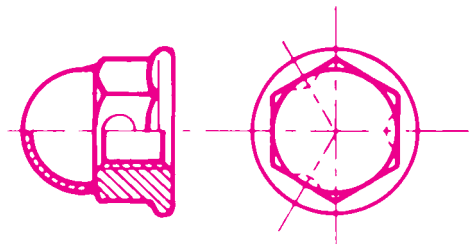

Self-locking flange blind nut

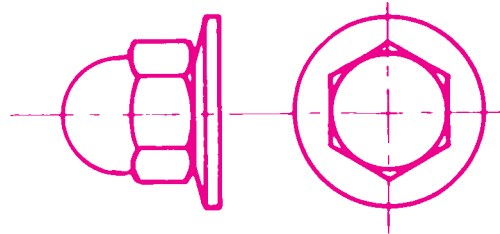

Blind nut with movable washer

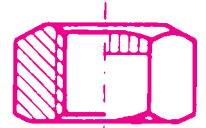

Self-locking conical nut

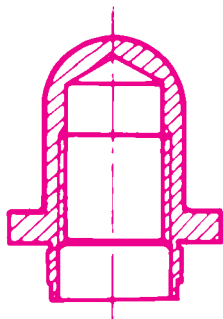

Self clinching blind nut

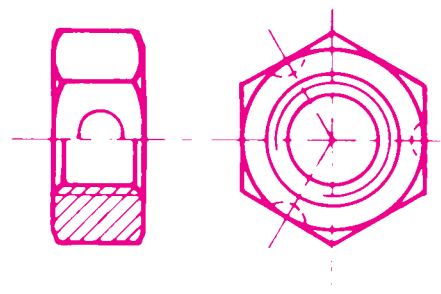

self-locking hexagon nut (din 980)

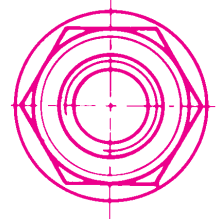
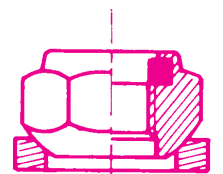

Self-locking spherical seat nut

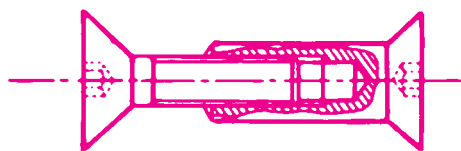

Comby special screw-nut

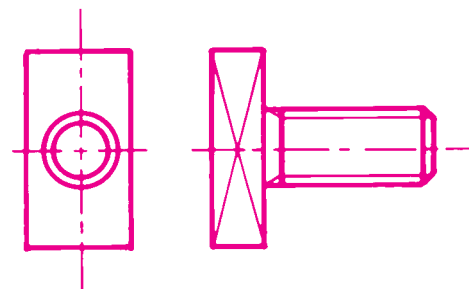

1/4 turn screw

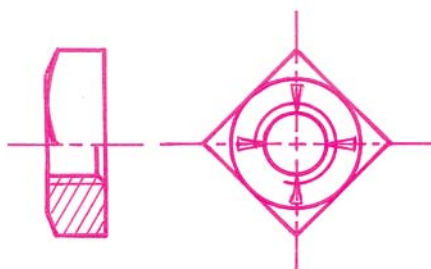

Square nut

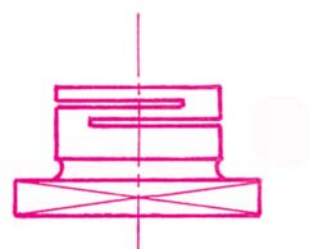

Double slotted square self-locking nut

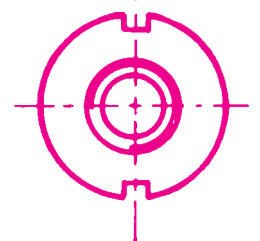

Tamper proof removable nut



Self locking stud

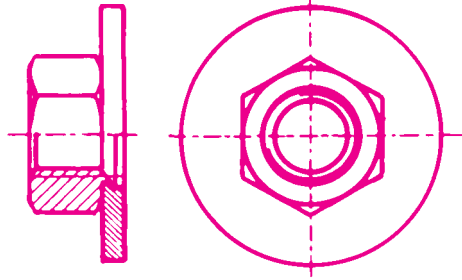

Nut with flat washer (combination)

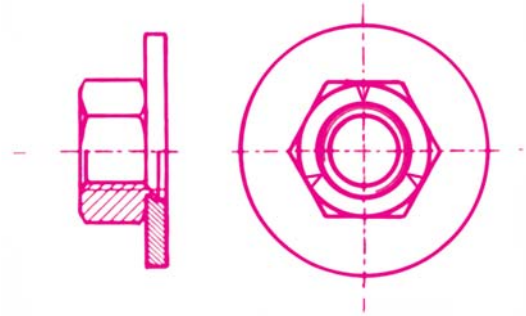

Self locking nut with flat washer

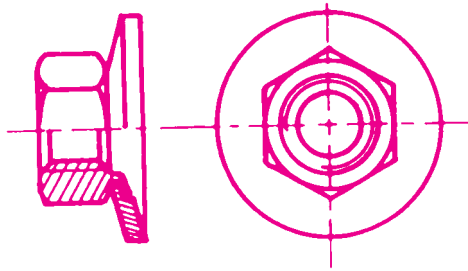
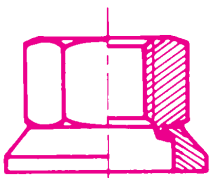

Hex nut with captive spring washer

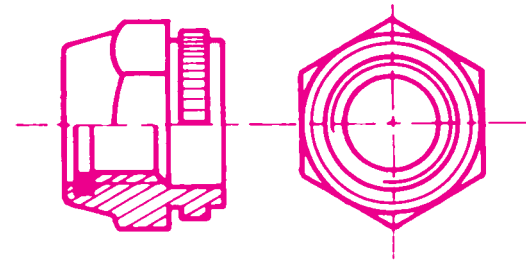

Nylon insert retreating nut

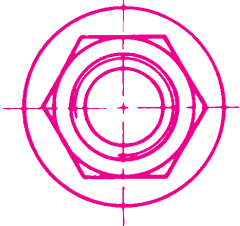

Wheel nut with mobile base

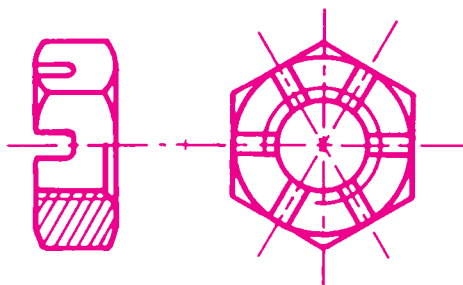

Low castle nut

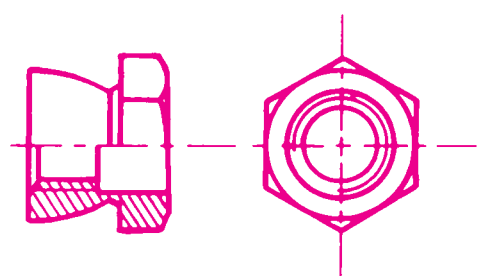

Self breaking nut

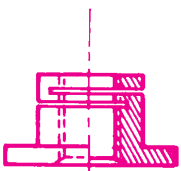

Self-locking threaded spacer

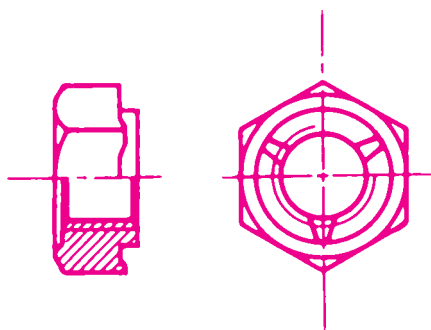

Self-locking weld nut

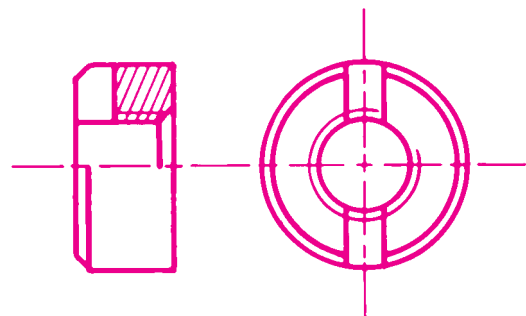

Slotted round nut